

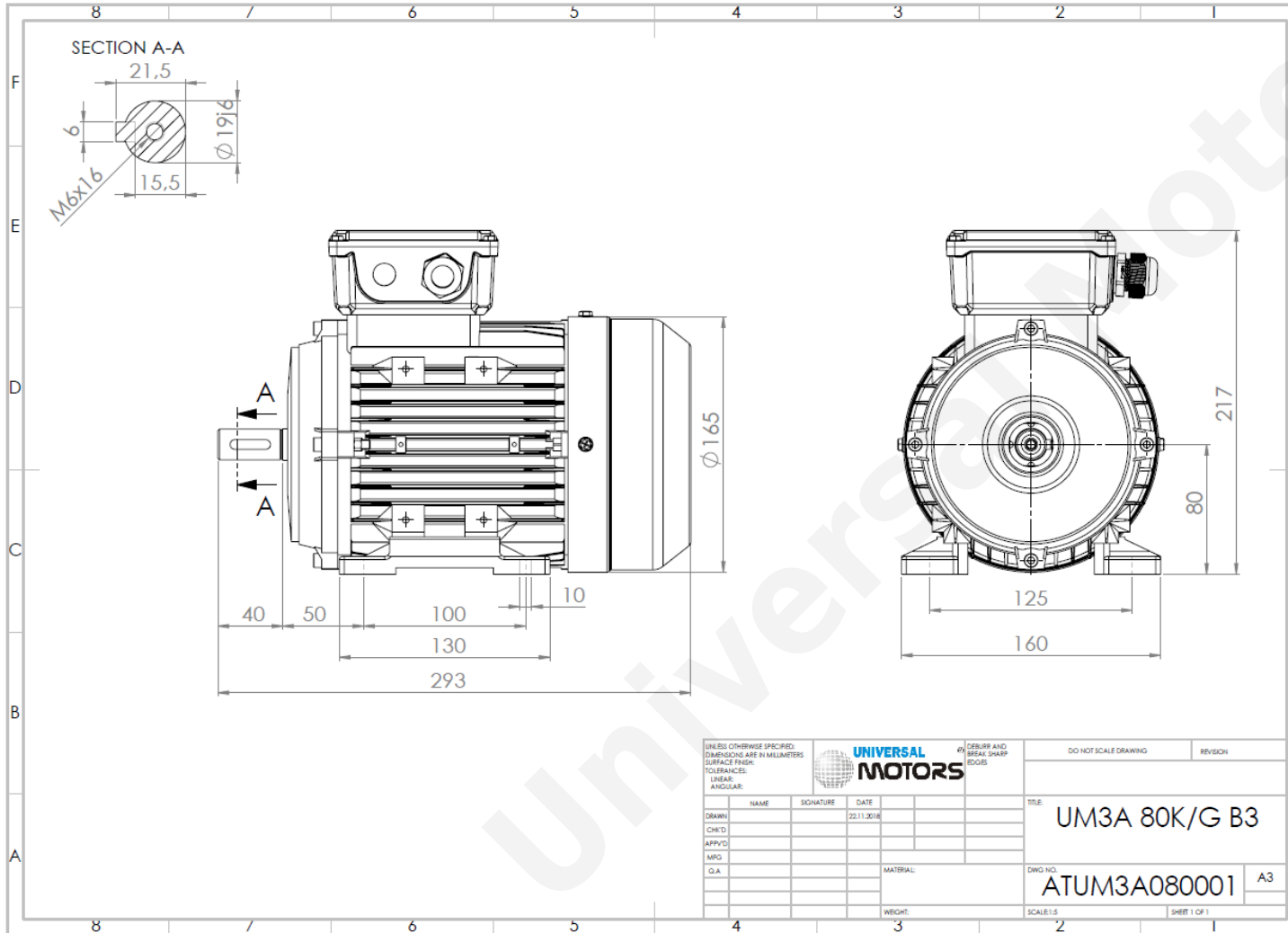

TECHNICAL DATA

Three Phase Electric Motors - Aluminum Frame
 PE31 80M2-4
 0.75 kW / 1 Cv
 1410 RPM



Motor type:	PE31 80M2-4
Output:	0.75 kW / 1 Cv
Speed (min ⁻¹):	1410 RPM
Frequency:	50 Hz
Voltage:	400 V
Current:	1.78 A
Power factor (Cos Ø):	0.75
Poles:	4
Insulation class:	F
Temperature rise Class:	B
Efficiency 50%:	80.4 %
Efficiency 75%:	81.3 %
Efficiency 100%:	82.5 %
Torque:	5.1 N.m
Tstarting/Tnominal:	2.3
Istarting/Inominal:	6.5
Tmaximum/Tnominal:	2.3
Noise:	71 Db(A)
Weight:	12 Kg
Bearing DE:	6204 2Z C3
Bearing NDE:	6204 2Z C3

Regime - S1

Altitude - 1000m

Environment Temperature - 40°C

CONTACTS:

UNIVERSAL MOTORS Tel: +351 252 299 080
 Rua de São Brás,745 Fax: +351 252 299 089
 4480-782 VILA DO CONDE Mail: geral@universalmotors.pt

* References applied only in the UK